

E instruments

IRtech Radiamatic IR20 VLS series

Video Advanced Split with Dual Laser Pointer Process Infrared Thermometers

IRtech
Infrared Technology

- Temperature range up to 2200°C
- Optical resolution up to 300:1
Close focus 0,5mm
- 1.6 μ m, 1 μ m, 2.3 μ m,
Spectral response
- Built-in Videocamera
for aiming (USB/Ethernet)
- Dual laser true target pointer
- Analog output 4-20mA, V, Tc J/K
- 2 Alarms board
- Up to 70°C of ambient
temperature without cooling
- Up to 1mS response time
- Signal processing
- Remote Control Display with settings
- USB / RS232 / RS485 / Profibus
and Ethernet interface with
IR Settings Windows software



IRtech Radiamatic IR20 series is an advanced infrared thermometer with split architecture using a measuring head with a separated electronics module. The standard remote control display make easy to startup and maintenance. All the settings, including emissivity, are available on panel and can be modified with built-in keyboard. The dual laser aiming simplify the alignment of the thermometer on the target identifying the real area of measurement. The laser can be powered and switched on directly by keyboard or remotely by digital interface. The temperature of the measuring head is monitored switching off the laser if over 50°C to avoid any damage. The modular capability allow to install various digital interface and a board with two relays of alarms. This will avoid to install an additional panel meter. The powerful signal processor allow to adapt the measurement to the requirement of the application. Video aiming system built-in allow easy alignment on special condition (software can record video with temperature data).



Models

Model	Temp range	FF 3600mm	SF 1200mm	CF1 70mm	CF2 150mm	CF3 200mm	CF4 450mm
100 160 L 150:1	100L : 485-1050°C 160L : 250-800°C	24mm	7,3mm	not available	1mm	1,3mm	3mm
100 160 H 300:1	100H : 650-1800°C 160H : 385-1600°C 100H1 : 800-2200°C 160H1 : 490-2000°C	12mm	3,7mm	not available	0,5mm	0,7mm	1,5mm
230 L 60:1	50-400°C	60mm	18,3mm	1,2mm	2,5mm	3,3mm	7,5mm
230 H 100:1	100-600°C	36mm	11mm	0,7mm	1,5mm	2mm	4,5mm
230 H1 H2 H3 100:1	H1: 150-1000°C H2: 200-1500°C H3: 250-1800°C	12mm	3,7mm	not available	0,5mm	0,7mm	1,5mm

Common specifications

Emissivity / Gain / IR windows :
Adjustable 0.100 - 1.000

Working temperature:
-20 to +70°C / 10-95% RH non condensing (50°C with laser on). Storage -20 to +85°C

Vibration & Shock:
IEC 68-2-6: 3G, 11-200Hz, any axis
IEC 68-2-27: 50G, 11mS, any axis

Environmental rating :
IP65 (NEMA-4)

Analog output :
0/4-20mA (500ohm), 0-5/10V, Tc J,K, Alarm

Analog input:
External emissivity, ambient temperature compensation, trigger

Digital output board:
Relay : 2x60V DC / 42 V ACeff; 0,4A; optically isolated
USB, RS232, RS485, CAN, Profibus, Ethernet

Power supply:
8..36 V DC

Functions:
Peak hold, Valley hold, average, extended hold, threshold and hysteresis.

Video:
640x480 pixel, 3,1°x2,4° FOV, 30 Hz

Sensing head

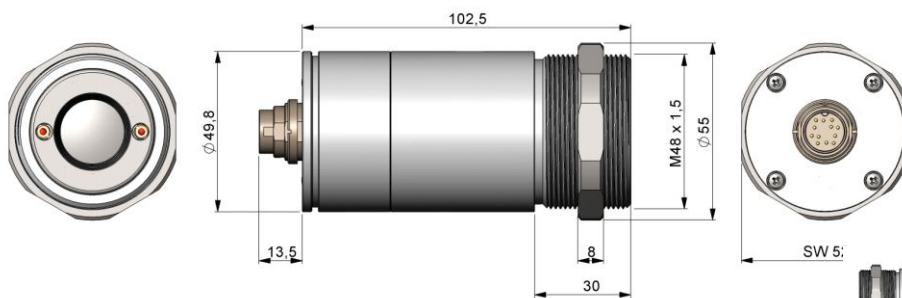

Electronics

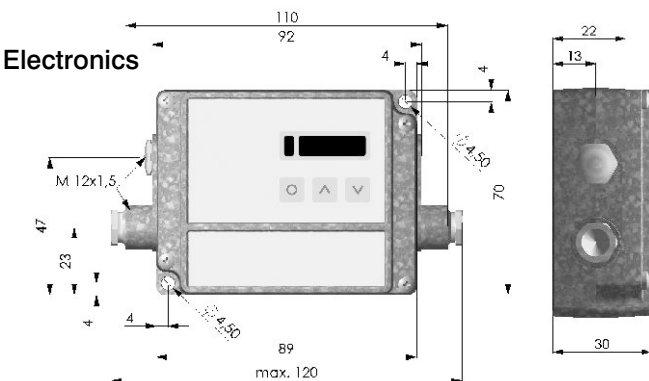

Dimensions

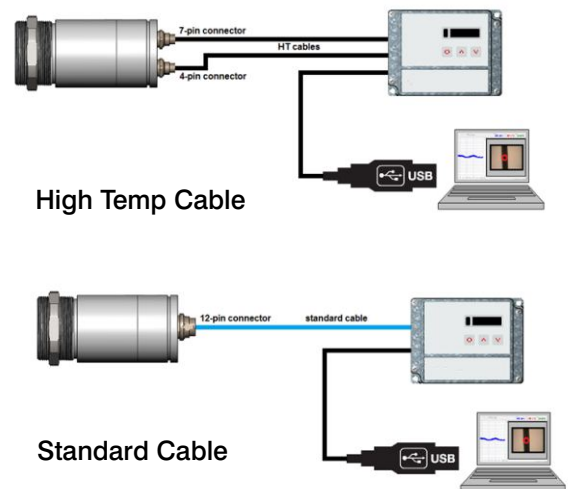

● **IR Settings Windows Software**

Software allows sensor setup and remote control. The real time graphic display and datalogging show the temperature trends with 1mS sampling.

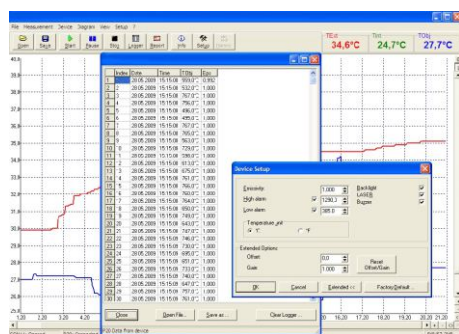

Ordering Code

Code	Model
IR20 VLS	IRtech IR20 includes mounting nut and bracket ACCTFLB & instruction manual.
Table A	Spectral response & Range (see table above)
	100 L - 100H - 100H1
	160 L - 160 H - 160H1
	230 L - 230 H
	230 H1 - 230 H2 - 230 H3
Table B	Optics (see table above)
	SF Standard focus optic
	CFx Close focus optic
	FF Far distance optic
Table C	Cable Head/Electronics (standard 3mt)
	C5-10 5/10 mt standard cable
	C3H-5H-10H 3/5/10 mt high temperature cable
Table D	Report of Calibration
	0 none
	C EA traceable with data
IR20 VLS-100 - SF - C3 - 0	Typical ordering code

USB board and cable with Windows IR Setting software included

Optics

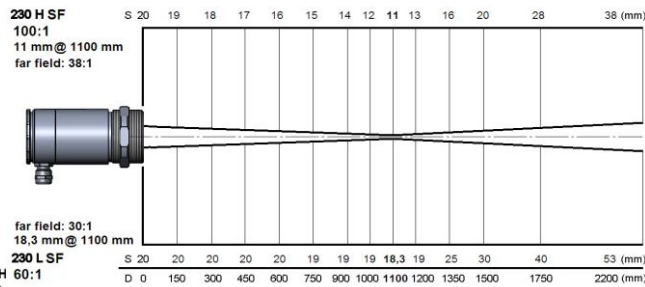
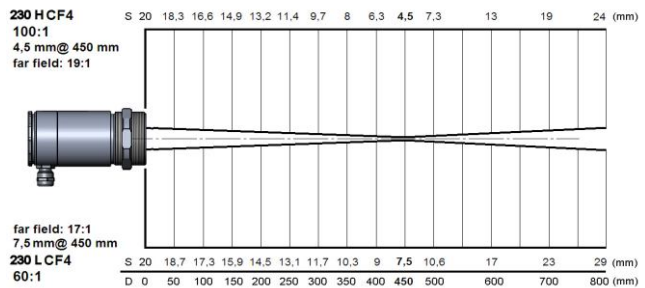
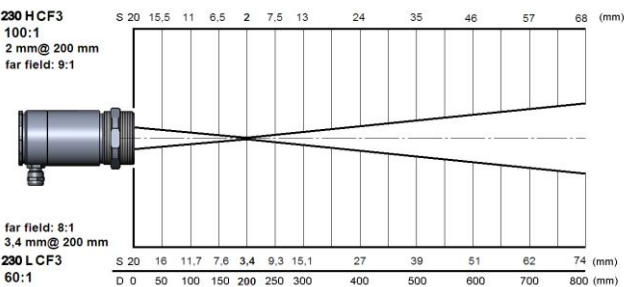
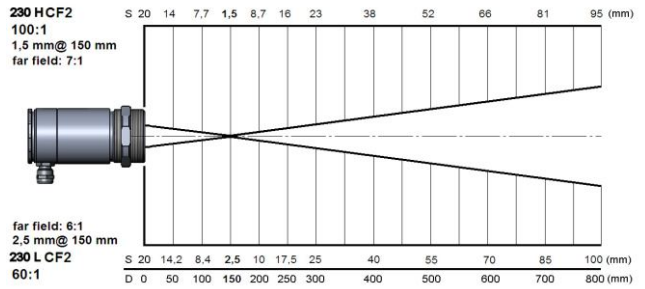
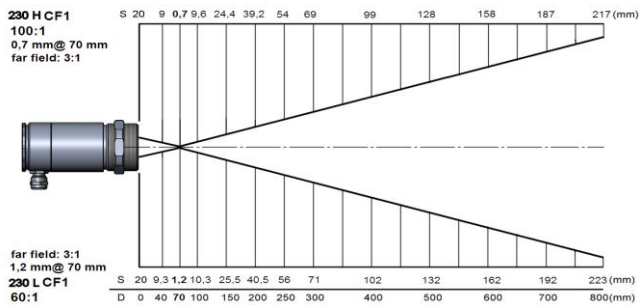

D = Distance
S = Spotsize

IRtec Radiamatic IR 20 LS 230

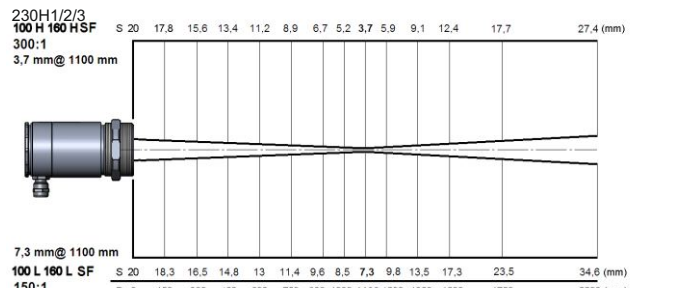
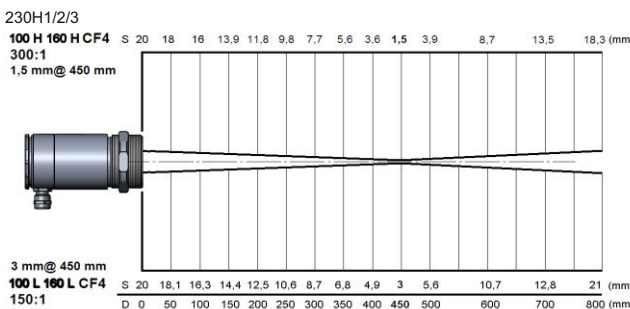
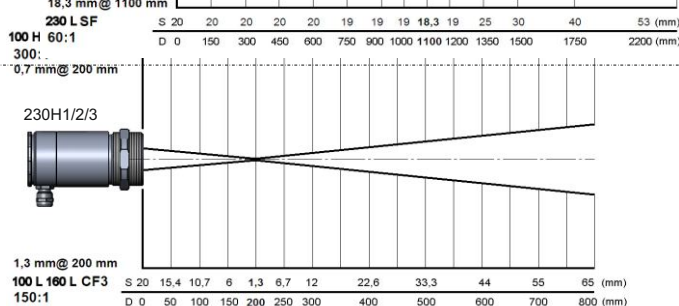
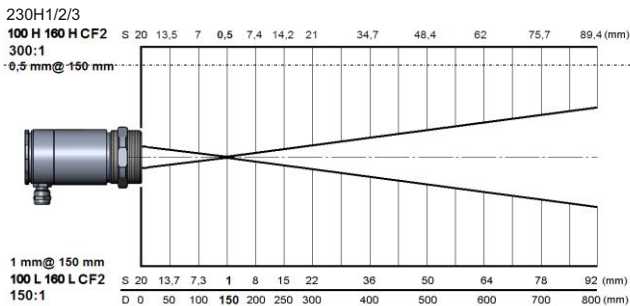

D = Distance
S = Spotsize

IRtec Radiamatic IR 20 LS 100 160 050

230H1, H2, H3

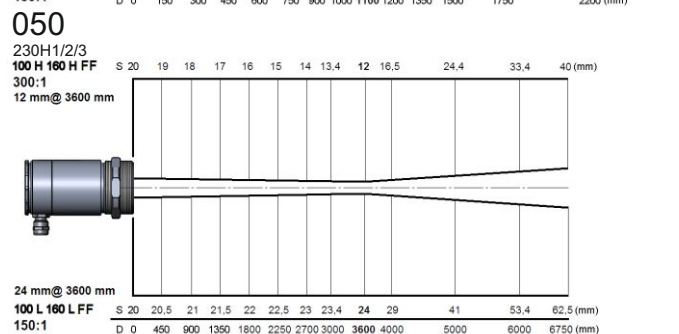

Models

Base Model	Radiamatic IR20		Radiamatic IR20		Radiamatic IR20	
Type	VLS 100 T150/T300		VLS 160 T150/T300		VLS 230 T100/T300	
Classification/ special features	Advanced 1 sensor with laser sighting for high temp. metal applications		Advanced 1,6 sensor with laser sighting for high temp. metal applications		Advanced 2,3 sensor with laser sighting for low/ medium temp. metal applications	
Detector	Si		InGaAs		extended InGaAs	
Sensing head exchangeable	■		■		■	
Head cable shortening	■ [max. 6m]		■ [max. 6m]		■ [max. 6m]	
Thread (sensing head)	M48x1,5		M48x1,5		M48x1,5	
Spectral range	1,0 µm		1,6 µm		2,3 µm	
Temperature ranges	L: 485...1050°C 650...1800°C H1: 800...2200°C		L: 250...800°C 385...1600°C H1: 490...2000°C		L: 50...400°C H: 100...800°C H1: 150...1000°C H2: 200...1500°C H3: 250...1800°C	
Temperature resolution	0,1°C		0,1°C		0,1°C	
Optical resolution	L: 150:1/ H: 300:1		L: 150:1/ H: 300:1		L: 60:1/ H: 100:1/ H1-H3: 300:1	
Option: CF lens	-		-		-	
Smallest spot (CF optics/ add. CF lens)	0,5mm@ 150mm		0,5mm@ 150mm		0,7mm@ 70mm	
Smallest spot (SF optics)	3,7mm@1100mm		3,7mm@1100mm		11mm@1100mm	
Sighting	double laser + VIDEO		double laser + VIDEO		double laser + VIDEO	
Response time (90%)	1ms		1ms		1ms	
Accuracy			±(0,3% Tmeas+2°C)		±(0,3% Tmeas+2°C)	
0-20mA/ 4-20mA/ 0-5V/ 0-10V/ t/c (K/J)	■ / ■ / ■ / ■ / ■		■ / ■ / ■ / ■ / ■		■ / ■ / ■ / ■ / ■	
Second analog output	-		-		-	
USB/ RS232/ RS485/ Profibus/ Ethernet	■ / ■ / ■ / ■ / ■		■ / ■ / ■ / ■ / ■		■ / ■ / ■ / ■ / ■	
Peak/ Valley/ AVG/ Advanced hold	■ / ■ / ■ / ■		■ / ■ / ■ / ■		■ / ■ / ■ / ■	
T _{amb} Head min.	-20°C		-20°C		-20°C	
T _{amb} Head max.	70°C		70°C		70°C	
T _{amb} Electronics max.	70°C		70°C		70°C	
Functional inputs/ number	■ / 3		■ / 3		■ / 3	
External emissivity adjustment	■		■		■	
External ambient control	■		■		■	
Trigger input for reset of hold functions	■		■		■	
Digital I/O pins	-		-		-	
Simultaneous analog and digital output	■		■		■	
Alarm output alternatively to analog output	■		■		■	
Additional alarm output	■		■		■	
Power supply	8-36 VDC		8-36 VDC		8-36 VDC	
Standard cable length	3m		3m		3m	
Cable length options	6/ 10m		6/ 10m		6/ 10m	

Mechanical Accessories



IR20 laser with water cooled housing and air purge collar

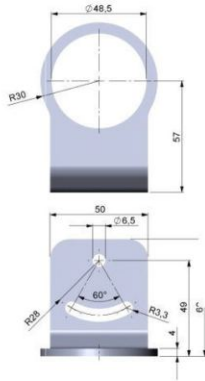

Mounting bracket (fixed) for IR20 laser

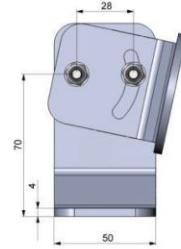

Mounting bracket (adjustable) for IR20 laser

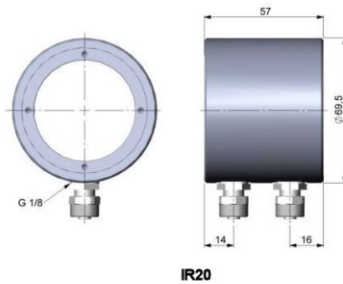

IR20

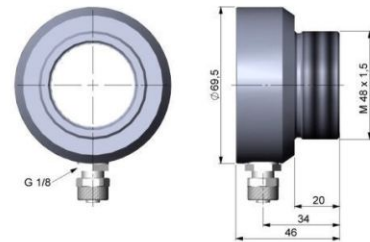

Water cooled housing for IR20 laser

Air purge collar for IR20 laser

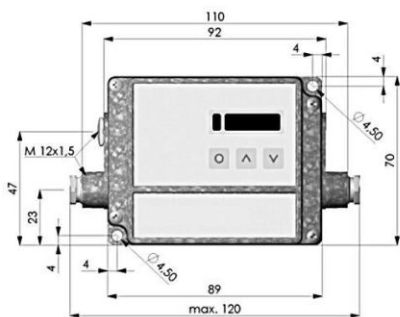

Electronics for IR20 laser

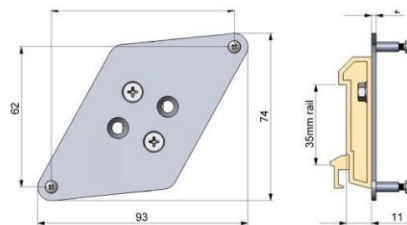

DIN rail mount adaptor for IR20 electronics

